

SERVO SYSTEMS CO.

Low Profile Series Miniature Linear Stages

Model: MLPS-3-10

Description: 3 inch travel linear stage with anti-backlash lead-screw assembly, profiled linear rails, and two (one per rail) linear bearings

Motor Mount: Standard NEMA 23

Dimensions:

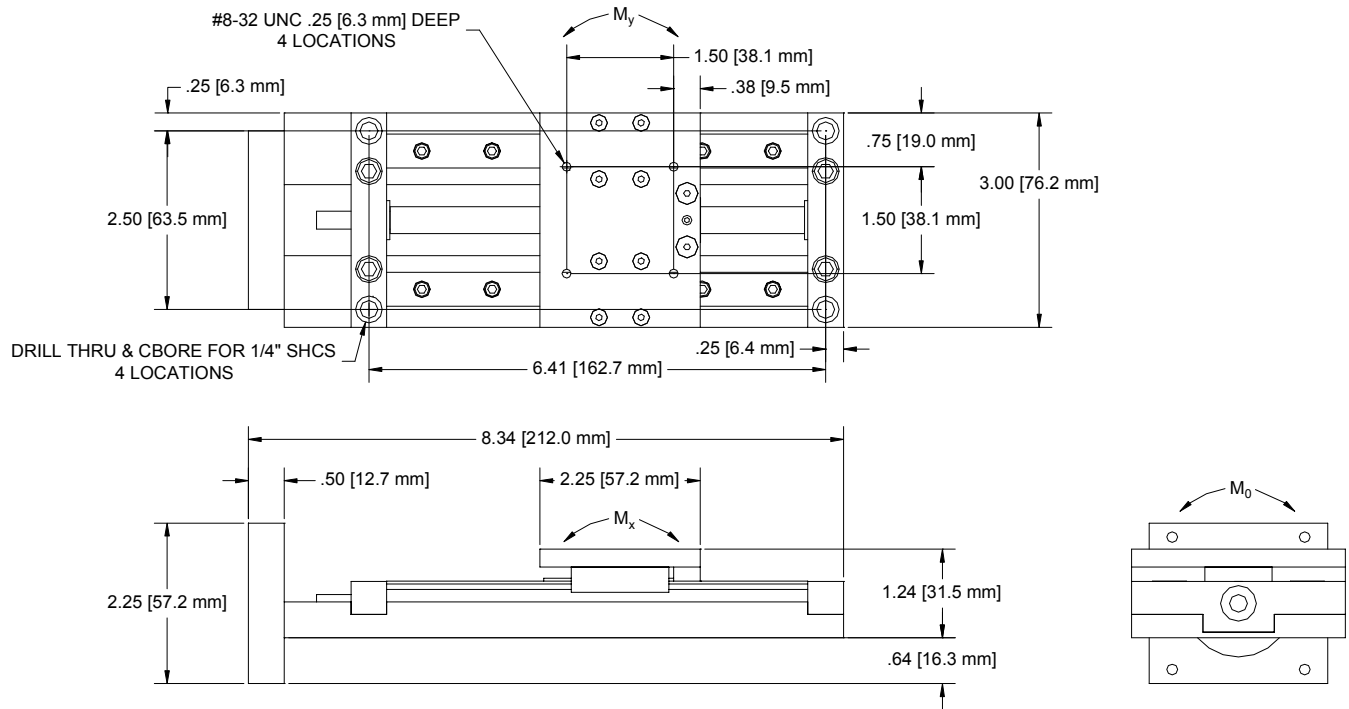

Specifications:

Unit Weight	2.0 lb.	Linear Speed	15 in./sec.
Moving Mass	0.372 lb.	Leadscrew Efficiency	81%
Travel Length	3.62 in.	Bidirectional Repeatability	0.0005 in.
Screw Inertia	6.885E-06 lb.-in.-sec. ²	Pricing Information	MLPS-3-10*
Axial Moment (M_0)	90.26 in.-lb.	Optional Accessories	MLPS-MFT* Mounting Foot MLPS-xLS* Dual Position Limit / Home Sensors LPS-MCH* Manual Crank Handle LPS-MSH* Motor Shaft Crank Handle - fits 1/4" rear motor shaft
Perpendicular Moments (M_x & M_y)	48.6 in.-lb.		
Maximum Dynamic Load	10 lb.		
Payload	9.628 lb.		
Drag Torque	3 oz.-in.		
Standard Lead	0.5 in./rev.		

Notes: Stock screw pitches come in 1 in., .5 in., .25 in., and .2 in.; other screw pitches available upon request

*Contact Servo Systems Co. via phone or e-mail for pricing information

