

SERVO SYSTEMS CO.

Low Profile Series Heavy Duty Linear Stages

Model: HLPS-35-150

Description: 35 inch travel linear stage with anti-backlash lead-screw assembly, profiled linear rails, and four (two per rail) linear bearings

Motor Mount: Standard NEMA 23

Dimensions:

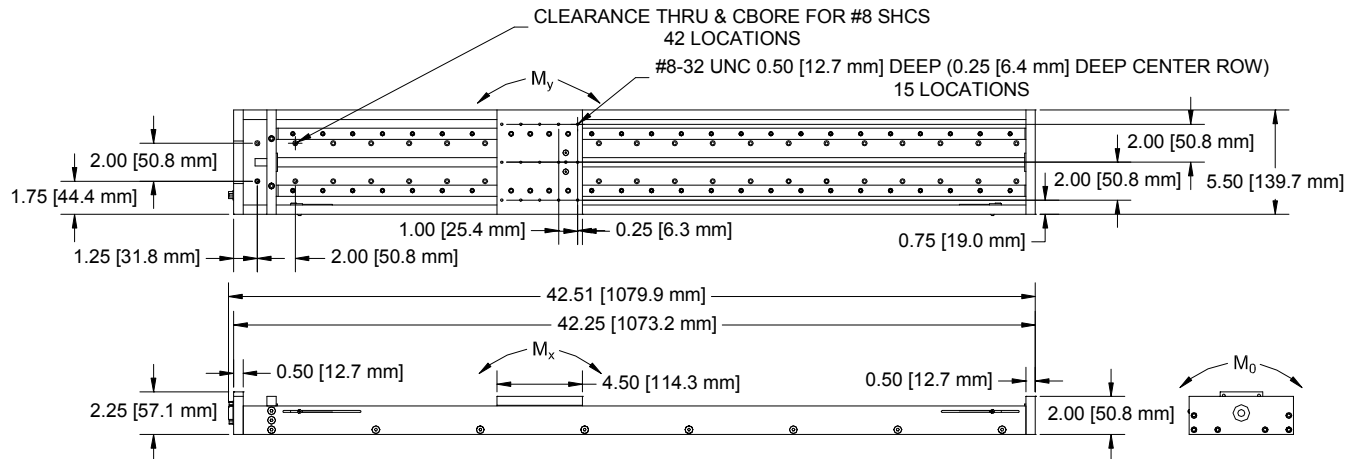

Specifications:

Unit Weight	25.6 lb.	Linear Speed	15 in./sec.
Moving Mass	2.285 lb.	Leadscrew Efficiency	84%
Travel Length	35.00 in.	Bidirectional Repeatability	0.0005 in.
Screw Inertia	1.335E-04 lb.-in.-sec. ²	Pricing Information	HLPS-35-150*
Axial Moment (Mo)	319.40 in.-lb.	Optional Accessories	LPS-MFT* Mounting Foot HLPS-MCH* Manual Crank Handle LPS-MSH* Motor Shaft Crank Handle - fits 1/4" rear motor shaft
Perpendicular Moments (Mx & My)	152.75 in.-lb.		
Maximum Dynamic Load	150 lb.		
Payload	147.7 lb.		
Drag Torque	5 oz.-in.		
Standard Lead	1.0 in./rev.		

Notes: Stock screw pitches come in 1 in., .5 in., .25 in., and .2 in.; other screw pitches, motor mount and higher accuracy screws available upon request; dual position limit / home sensors are embedded in the table at no extra fee (see below for more info)
 *Contact Servo Systems Co. via phone or e-mail for pricing information



SERVO SYSTEMS CO.

Low Profile Series Heavy Duty Linear Stages (cont'd)

HLPS Dual Position Limit / Home Sensor Specifications:

Power Consumption	<0.29 W
Max. Switching Current	200 mA
Voltage Drop	<1.8 V
Max. Switching Frequency	2 kHz
Output Indicator	Red LED
Protection Class	IP67 (sensor only)
Connection	9-pin D-sub Male
Pin Function	Pin 1: Supply Voltage (6-30 VDC) Pin 3: Signal Ground Pin 5: Negative Limit (near motor) Pin 7: Positive Limit (far end)