

Description

The DigiFlex Performance (DP) Series digital servo drives are designed to drive brushed and brushless servomotors. These fully digital drives operate in torque, velocity, or position mode and employ Space Vector Modulation (SVM), which results in higher bus voltage utilization and reduced heat dissipation compared to traditional PWM. The command source can be generated internally or can be supplied externally. In addition to motor control, these drives feature dedicated and programmable digital and analog inputs and outputs to enhance interfacing with external controllers and devices.

This DP Series drive features a single RS-232/RS-485 interface used for drive configuration and setup. Drive commissioning is accomplished using DriveWare, available at www.a-m-c.com.

All drive and motor parameters are stored in non-volatile memory.

Power Range

| | |
|--------------------|-------------------------------|
| Peak Current | 60 A (42.4 A _{RMS}) |
| Continuous Current | 30 A (21.2 A _{RMS}) |
| Supply Voltage | 155 - 480 VAC |



Features

- ▲ Four quadrant regenerative operation
- ▲ Space vector modulation (SVM) technology
- ▲ Fully digital state-of-the-art design
- ▲ Programmable gain settings
- ▲ Fully configurable current, voltage, velocity and position limits
- ▲ PIDF velocity loop
- ▲ PID + FF position loop
- ▲ Compact size, high power density

MODES OF OPERATION

- Current
- Position
- Velocity

COMMAND SOURCE

- ±10 V Analog
- 5V Step & Direction
- Encoder Following

FEEDBACK SUPPORTED

- Halls
- Incremental Encoder
- ±10 V Analog
- Auxiliary Incremental Encoder

INPUTS/OUTPUTS

- 3 Programmable Analog Inputs
- 0 Programmable Analog Outputs
- 5 Programmable Digital Inputs (Differential)
- 5 Programmable Digital Inputs (Single-Ended)
- 4 Programmable Digital Outputs



COMPLIANCES & AGENCY APPROVALS

- RoHS
- UL/cUL Pending
- CE Pending

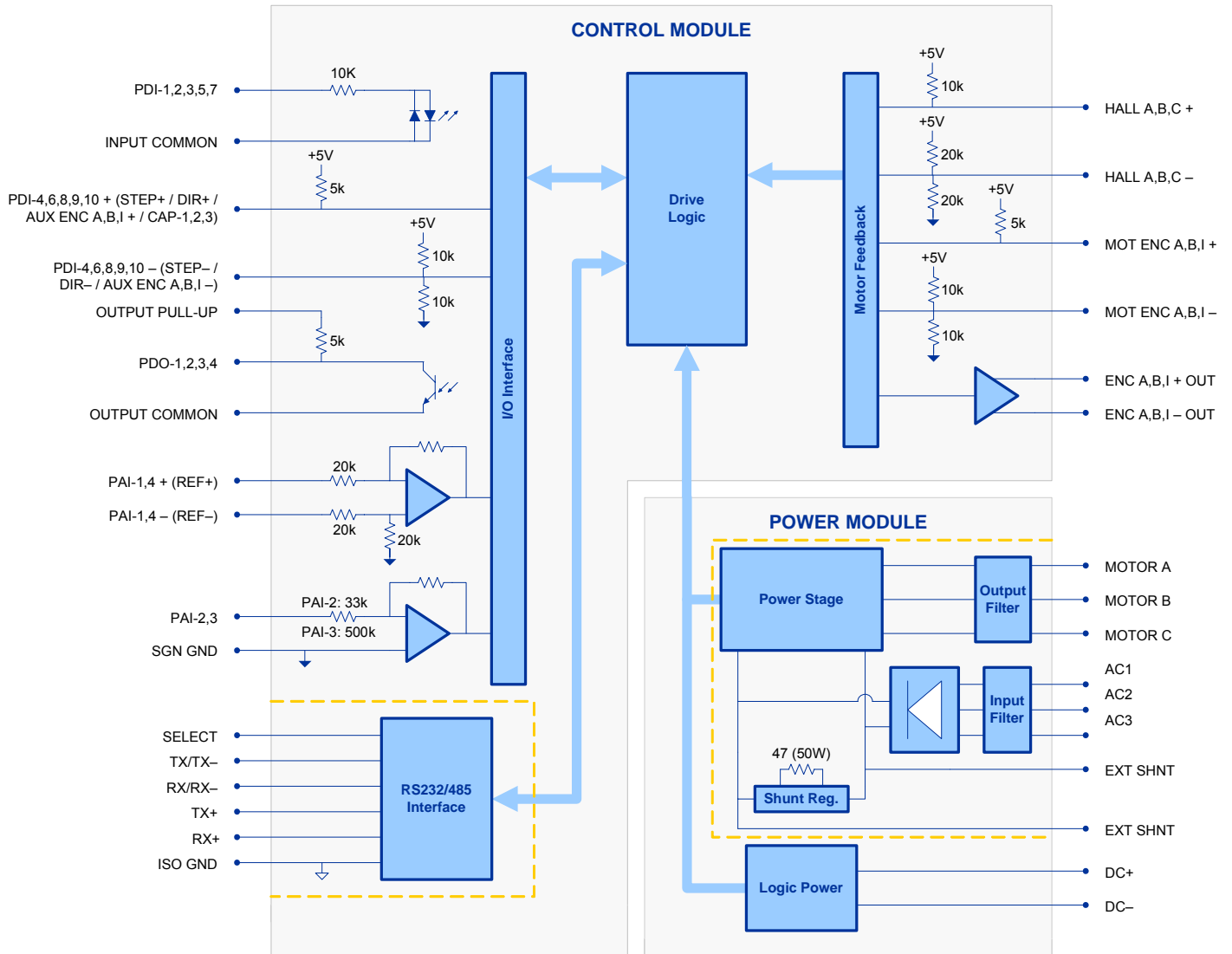
BLOCK DIAGRAM



Approvals and Compliances

| | |
|---|---|
|  | <p>US and Canadian safety compliance with UL 508c, the industrial standard for power conversion electronics. UL registered under file number E140173. Note that machine components compliant with UL are considered UL registered as opposed to UL listed as would be the case for commercial products.</p> |
|  | <p>Compliant with European CE for both the Class A EMC Directive 89/336/EEC on Electromagnetic Compatibility (specifically EN 61000-6-4:2001, EN 61000-6-2:2001, EN 61000-3-2:2000, and EN 61000-3-3:1995/A1:2001) and LVD requirements of directive 73/23/EEC (specifically EN 60204-1), a low voltage directive to protect users from electrical shock.</p> |
|  | <p>RoHS (Reduction of Hazardous Substances) is intended to prevent hazardous substances such as lead from being manufactured in electrical and electronic equipment.</p> |

SPECIFICATIONS

| Power Stage Specifications | | |
|---|---------|---|
| Description | Units | Value |
| AC Supply Voltage | VAC | 155 - 480 |
| DC Supply Voltage | VDC | 220 - 800 |
| Over Voltage Limit | VDC | 850 |
| Under Voltage Limit | VDC | 215 |
| Logic Supply Voltage | VDC | 20 - 30 |
| Peak Output Current | A | 60 |
| Maximum Continuous Output Current | A | 30 |
| Maximum Continuous Output Power | W | 24000 |
| Maximum Power Dissipation at Continuous Current | W | 1200 |
| Internal Braking Resistor | - | Yes |
| Minimum Load Inductance (Line-To-Line) ¹ | μH | 3000 |
| Switching Frequency | kHz | 10 |
| Control Specifications | | |
| Description | Units | Value |
| Communication Interfaces | - | RS-232, RS-485 |
| Command Sources | - | ±10 V Analog, 5V Step & Direction, Encoder Following |
| Feedback Supported | - | ±10 V Analog, Auxiliary Incremental Encoder, Halls, Incremental Encoder |
| Commutation Methods | - | Sinusoidal, Trapezoidal |
| Modes of Operation | - | Current, Position, Velocity |
| Motors Supported | - | Brushed, Brushless, Induction, Voice Coil |
| Hardware Protection | - | 40+ Configurable Functions, Over Current, Over Temperature (Drive & Motor), Over Voltage, Short Circuit (Phase-Phase & Phase-Ground), Under Voltage |
| Programmable Digital Inputs/Outputs (PDIs/PDOs) | - | 10/4 |
| Programmable Analog Inputs/Outputs (PAIs/PAOs) | - | 3/0 |
| Current Loop Sample Time | μs | 100 |
| Velocity Loop Sample Time | μs | 100 |
| Position Loop Sample Time | μs | 100 |
| Max Encoder Line Frequency ² | MHz | 4 |
| Mechanical Specifications | | |
| Description | Units | Value |
| Size (H x W x L) | mm (in) | 330 x 256 x 63 (13 x 10.1 x 2.5) |
| Heatsink (Base) Temperature Range ³ | °C (°F) | 0 - 65 (32 - 149) |
| Storage Temperature Range | °C (°F) | -40 - 85 (-40 - 185) |
| Cooling System | - | Natural Convection |
| Form Factor | - | Stand Alone |
| IP Rating | - | IP10 |
| +24V LOGIC Connector | - | 2-port, 5.08 mm spaced, enclosed, friction lock header |
| AUX ENCODER Connector | - | 15-pin, high-density, male D-sub |
| COMM Connector | - | 9-pin, female D-sub |
| DC BUS Connector | - | 4-port, 7.62 mm spaced, enclosed, friction lock header |
| FEEDBACK Connector | - | 15-pin, high-density, female D-sub |
| I/O Connector | - | 26-pin, high-density, female D-sub |
| MOTOR POWER Connector | - | 4-port, 7.62 mm spaced, enclosed, friction lock header |
| POWER Connector | - | 4-port, 7.62 mm spaced, enclosed, friction lock header |

Notes

1. Low inductance motors, such as 'pancake' and 'basket-wound', require external inductors. The Minimum Load Inductance provided assumes the highest allowed bus voltage. Lower inductances are acceptable for lower bus voltages.
2. Pre-quadrature frequency.
3. Additional cooling and/or heatsink may be required to achieve rated performance.

PIN FUNCTIONS

| +24V LOGIC - Logic Power Connector | | | |
|---|-----------|---------------------|-----|
| Pin | Name | Description / Notes | I/O |
| 1 | LOGIC PWR | Logic Supply Input | I |
| 2 | LOGIC GND | Logic Supply Ground | GND |

| AUX ENCODER - Auxiliary Feedback Connector | | | |
|---|-------------------------------|---|------|
| Pin | Name | Description / Notes | I/O |
| 1 | RESERVED | Reserved | - |
| 2 | RESERVED | Reserved | - |
| 3 | RESERVED | Reserved | - |
| 4 | PDI-8 + (AUX ENC A+ / CAP-2) | Programmable Digital Input or Auxiliary Encoder or High Speed Capture | I |
| 5 | PDI-8 - (AUX ENC A-) | Programmable Digital Input or Auxiliary Encoder (For Differential Signals Only) | I |
| 6 | PDI-9 + (AUX ENC B+ / CAP-2) | Programmable Digital Input or Auxiliary Encoder or High Speed Capture | I |
| 7 | PDI-9 - (AUX ENC B-) | Programmable Digital Input or Auxiliary Encoder (For Differential Signals Only) | I |
| 8 | PDI-10 + (AUX ENC I+ / CAP-1) | Programmable Digital Input or Auxiliary Encoder or High Speed Capture | I |
| 9 | PDI-10 - (AUX ENC I-) | Programmable Digital Input or Auxiliary Encoder (For Differential Signals Only) | I |
| 10 | SGN GND | Signal Ground | SGND |
| 11 | SGN GND | Signal Ground | SGND |
| 12 | SGN GND | Signal Ground | SGND |
| 13 | +5V OUT | +5V Encoder Supply Output (Short Circuit Protected) | O |
| 14 | PAI-4 + | Differential Programmable Analog Input | I |
| 15 | PAI-4 - | | I |

| COMM - RS232/RS485 Communication Connector | | | |
|---|----------------------|--|------|
| Pin | Name | Description / Notes | I/O |
| 1 | SELECT | RS232/485 selection. Pull to ground (CN1-5) for RS485. | I |
| 2 | RS232 TX / RS485 TX- | Transmit Line (RS-232 or RS-485) | O |
| 3 | RS232 RX / RS485 RX- | Receive Line (RS-232 or RS-485) | I |
| 4 | RESERVED | Reserved | - |
| 5 | ISO GND | Isolated Signal Ground | IGND |
| 6 | RS485 TX+ | Transmit Line (RS-485) | O |
| 7 | RESERVED | Reserved | - |
| 8 | RS485 RX+ | Receive Line (RS-485) | I |
| 9 | RESERVED | Reserved | - |

| DC BUS - Power Connector | | | |
|---------------------------------|------|---|-----|
| Pin | Name | Description / Notes | I/O |
| 1 | DC- | Internal DC Bus Voltage (Can Be Used To Connect External Shunt Regulator) | O |
| 2 | DC- | | O |
| 3 | DC+ | | O |
| 4 | DC+ | | O |

| FEEDBACK - Feedback Connector | | | |
|--------------------------------------|------------|---|-----|
| Pin | Name | Description / Notes | I/O |
| 1 | HALL A+ | Commutation Sensor Inputs | I |
| 2 | HALL B+ | | I |
| 3 | HALL C+ | | I |
| 4 | MOT ENC A+ | Differential Encoder A Channel Input (For Single Ended Signals Use Only The Positive Input) | I |
| 5 | MOT ENC A- | | I |
| 6 | MOT ENC B+ | Differential Encoder B Channel Input (For Single Ended Signals Use Only The Positive Input) | I |
| 7 | MOT ENC B- | | I |
| 8 | MOT ENC I+ | Differential Encoder Index Input (For Single Ended Signals Use Only The Positive Input) | I |
| 9 | MOT ENC I- | | I |
| 10 | HALL A- | Commutation Sensor Input (For Differential Signals Only) | I |

| | | | |
|----|---------|--|------|
| 11 | HALL B- | Commutation Sensor Input (For Differential Signals Only) | I |
| 12 | SGN GND | Signal Ground | SGND |
| 13 | +5V OUT | +5V Encoder Supply Output (Short Circuit Protected) | O |
| 14 | PAI-3 | Programmable Analog Input | I |
| 15 | HALL C- | Commutation Sensor Input (For Differential Signals Only) | I |

| I/O - Signal Connector | | | |
|------------------------|-----------------|--|------|
| Pin | Name | Description / Notes | I/O |
| 1 | PDO-1 | Isolated Programmable Digital Output | O |
| 2 | OUTPUT COMMON | Digital Output Common | OGND |
| 3 | PDO-2 | Isolated Programmable Digital Output | O |
| 4 | PDI-4 - (STEP-) | Programmable Digital Input or Step- (For Differential Signals Only) | I |
| 5 | PDI-6 - (DIR-) | Programmable Digital Input or Direction- (For Differential Signals Only) | I |
| 6 | PAI-1 | Programmable Analog Input | I |
| 7 | SGN GND | Signal Ground | SGND |
| 8 | OUTPUT PULL-UP | Digital Output Pull-Up | I |
| 9 | PDI-5 | Isolated Programmable Digital Input | I |
| 10 | PDO-3 | Isolated Programmable Digital Output | O |
| 11 | PDI-1 | Isolated Programmable Digital Input | I |
| 12 | PDI-2 | Isolated Programmable Digital Input | I |
| 13 | PDI-3 | Isolated Programmable Digital Input | I |
| 14 | PDO-4 | Isolated Programmable Digital Output | O |
| 15 | INPUT COMMON | Digital Input Common (Can Be Used To Pull-Up Digital Inputs) | IGND |
| 16 | SGN GND | Signal Ground | SGND |
| 17 | PDI-4 + (STEP+) | Programmable Digital Input or Step+ | I |
| 18 | PDI-6 + (DIR+) | Programmable Digital Input or Direction+ | I |
| 19 | PDI-7 | Isolated Programmable Digital Input | I |
| 20 | ENC A+ OUT | Buffered Encoder Channel A Output | O |
| 21 | ENC A- OUT | | O |
| 22 | ENC B+ OUT | Buffered Encoder Channel B Output | O |
| 23 | ENC B- OUT | | O |
| 24 | ENC I+ OUT | Buffered Encoder Index Output | O |
| 25 | ENC I- OUT | | O |
| 26 | SGN GND | Signal Ground | SGND |

| MOTOR POWER - Power Connector | | | |
|-------------------------------|---------|-------------------------|-----|
| Pin | Name | Description / Notes | I/O |
| 1 | PE | Protective Earth Ground | PE |
| 2 | MOTOR C | Motor Phase C | O |
| 3 | MOTOR B | Motor Phase B | O |
| 4 | MOTOR A | Motor Phase A | O |

| POWER - Power Connector | | | |
|-------------------------|------|---|-----|
| Pin | Name | Description / Notes | I/O |
| 1 | PE | Protective Earth Ground | PE |
| 2 | AC3 | AC Supply Input (Single Or Three Phase) | I |
| 3 | AC2 | | I |
| 4 | AC1 | | I |

HARDWARE SETTINGS

Switch Functions

| Switch | Description | Setting | |
|--------|--|---------|-----|
| | | On | Off |
| 1 | Bit 0 of binary value of drive address/ID. | 1 | 0 |
| 2 | Bit 1 of binary value of drive address/ID. | 1 | 0 |
| 3 | Bit 2 of binary value of drive address/ID. | 1 | 0 |
| 4 | Bit 3 of binary value of drive address/ID. | 1 | 0 |
| 5 | Bit 4 of binary value of drive address/ID. | 1 | 0 |
| 6 | Bit 5 of binary value of drive address/ID. | 1 | 0 |
| 7 | Bit 0 of binary value of drive bit rate setting. | 1 | 0 |
| 8 | Bit 1 of binary value of drive bit rate setting. | 1 | 0 |

Additional Details

The drive can be configured to use the address and/or bit rate stored in non-volatile memory by setting the address and/or bit rate value to 0. Use the table below to map actual bit rates to a bit rate setting.

| Bit Rate (kbits/sec) | | Value For Bit Rate Setting |
|-------------------------------|-------------------------------|----------------------------|
| CANopen | RS-485 | |
| Load from non-volatile memory | Load from non-volatile memory | 0 |
| 500 | 9.6 | 1 |
| 250 | 38.4 | 2 |
| 125 | 115.2 | 3 |

MECHANICAL INFORMATION
+24V LOGIC - Logic Power Connector

| | |
|-----------------------|--|
| Connector Information | 2-port, 5.08 mm spaced, enclosed, friction lock header |
| Mating Connector | Phoenix Contact: P/N 1757019 |

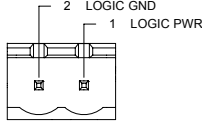

AUX ENCODER - Auxiliary Feedback Connector

| | |
|-----------------------|--|
| Connector Information | 15-pin, high-density, male D-sub |
| Mating Connector | AMP: Plug P/N 748365-1; Housing P/N 748677-1; Terminals P/N 748610-4 (loose) or 748610-2 (strip) |

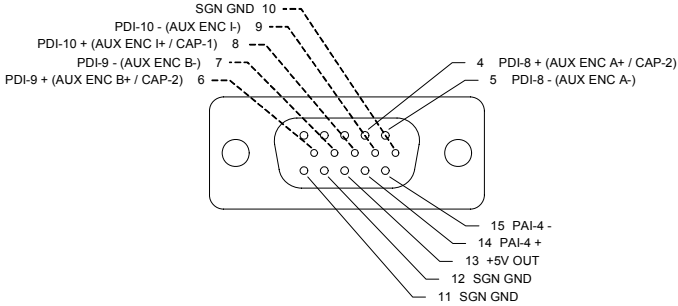

COMM - RS232/RS485 Communication Connector

| | |
|-----------------------|--|
| Connector Information | 9-pin, female D-sub |
| Mating Connector | AMP: Plug P/N 205204-4; Housing P/N 748677-1; Terminals P/N 5-66507-7 (loose) or 3-66507-0 (strip) |

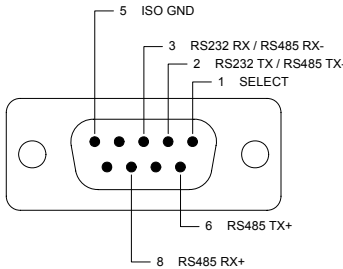

DC BUS - Power Connector

| | |
|-----------------------|--|
| Connector Information | 4-port, 7.62 mm spaced, enclosed, friction lock header |
| Mating Connector | Phoenix Contact: P/N 1804920 |

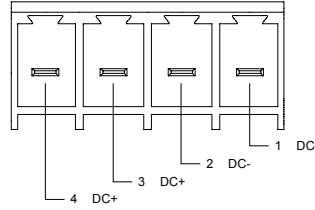

FEEDBACK - Feedback Connector

| | |
|-----------------------|--|
| Connector Information | 15-pin, high-density, female D-sub |
| Mating Connector | AMP: Plug P/N 748365-1; Housing P/N 748677-1; Terminals P/N 748333-4 (loose) or 748333-2 (strip) |

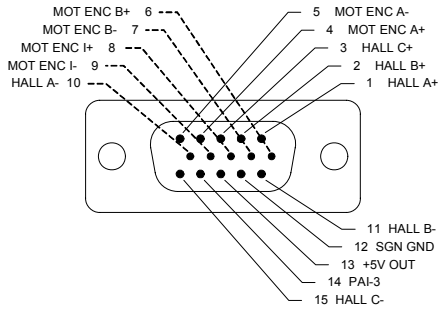

I/O - Signal Connector

| | |
|-----------------------|--|
| Connector Information | 26-pin, high-density, female D-sub |
| Mating Connector | AMP: Plug P/N 748365-1; Housing P/N 748677-2; Terminals P/N 748333-4 (loose) or 748333-2 (strip) |

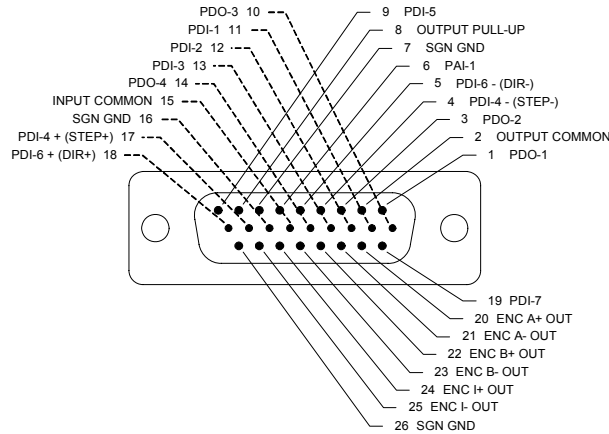

MOTOR POWER - Power Connector

| | |
|-----------------------|--|
| Connector Information | 4-port, 7.62 mm spaced, enclosed, friction lock header |
| Mating Connector | Phoenix Contact: P/N 1804920 |

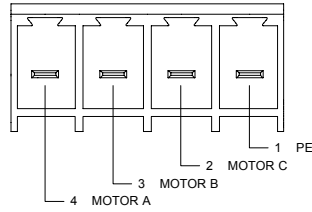

POWER - Power Connector

| | |
|-----------------------|--|
| Connector Information | 4-port, 7.62 mm spaced, enclosed, friction lock header |
| Mating Connector | Phoenix Contact: P/N 1804920 |

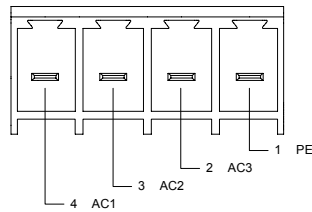

PART NUMBERING INFORMATION

Example: **D P R A N I E - 0 1 5 A 4 0 0**

| Drive Series | |
|--------------|----------------------|
| DP | DigiFlex Performance |

| Communication | |
|---------------|------------------|
| R | RS232/RS485 |
| C | CANopen or RS232 |
| Q | SynqNet |

| Command Inputs | |
|----------------|--|
| AN | Analog ($\pm 10V$) No Step & Direction |
| AL | Analog ($\pm 10V$) Low Voltage Step & Direction (5V) |
| AH | Analog ($\pm 10V$) High Voltage Step & Direction (24V) |
| NL | No Analog Low Voltage Step & Direction (5V) |
| NN | No Analog, No Step & Direction (Communication Interface Only) |

| Digital I/O | |
|-------------|-----------------------|
| I | Isolated (24V) |
| T | TTL (5V) Non-Isolated |

| Motor Feedback | |
|----------------|--------------------------------------|
| E | Incremental Encoder and/or Halls |
| R | Resolver |
| A | Absolute Sin/Cos (Hiperface & Endat) |
| S | Sin/Cos with Halls |

| Max DC Bus Voltage (V _{DC}) | |
|---------------------------------------|-----|
| 080 | 80 |
| 200 | 200 |
| 400 | 400 |
| 800 | 800 |

| Power and Logic Supply | |
|------------------------|---|
| A | AC Input +24V _{DC} User Logic Supply Required |
| N | AC Input Only No Logic Supply Required (Internal Supply) |
| B | DC Input Both Logic Supply Options (Internal or User) |
| L | DC Input Logic Supply Required |
| D | DC Input Only Internal Logic Supply |

| Peak Current (A _{0 to Peak}) | |
|--|-----|
| 015 | 15 |
| 016 | 16 |
| 020 | 20 |
| 025 | 25 |
| 030 | 30 |
| 040 | 40 |
| 060 | 60 |
| 100 | 100 |

DigiFlex® Performance™ series of products are available in many configurations. All models listed on the website are readily available, standard product offerings. Other combinations or possibilities can be made available for OEMs with volume requests of 100 or more. Contact Applications Engineering for further information and details.

All specifications in this document are subject to change without written notice. Actual product may differ from pictures provided in this document.