

Description

The DigiFlex Performance (DP) Series digital servo drives are designed to drive brushed and brushless servomotors. These fully digital drives operate in torque, velocity, or position mode and employ Space Vector Modulation (SVM), which results in higher bus voltage utilization and reduced heat dissipation compared to traditional PWM. The command source can be generated internally or can be supplied externally. In addition to motor control, these drives feature dedicated and programmable digital and analog inputs and outputs to enhance interfacing with external controllers and devices.

This DP Series drive features a single RS-232/RS-485 interface used for drive configuration and setup. Drive commissioning is accomplished using DriveWare, available at www.a-m-c.com.

All drive and motor parameters are stored in non-volatile memory.

Power Range

Peak Current	20 A (14.1 A _{RMS})
Continuous Current	10 A (7.1 A _{RMS})
Supply Voltage	155 - 480 VAC



Features

- ▲ Four quadrant regenerative operation
- ▲ Space vector modulation (SVM) technology
- ▲ Fully digital state-of-the-art design
- ▲ Programmable gain settings
- ▲ Fully configurable current, voltage, velocity and position limits
- ▲ PIDF velocity loop
- ▲ PID + FF position loop
- ▲ Compact size, high power density

MODES OF OPERATION

- Current
- Position
- Velocity

COMMAND SOURCE

- ±10 V Analog
- 5V Step & Direction
- Encoder Following

FEEDBACK SUPPORTED

- Resolver
- ±10 V Analog
- Auxiliary Incremental Encoder

INPUTS/OUTPUTS

- 3 High Speed Captures
- 4 Programmable Analog Inputs
- 1 Programmable Analog Output
- 3 Programmable Digital Inputs (Differential)
- 7 Programmable Digital Inputs (Single-Ended)
- 4 Programmable Digital Outputs



COMPLIANCES & AGENCY APPROVALS

- RoHS
- UL/cUL Pending
- CE Pending

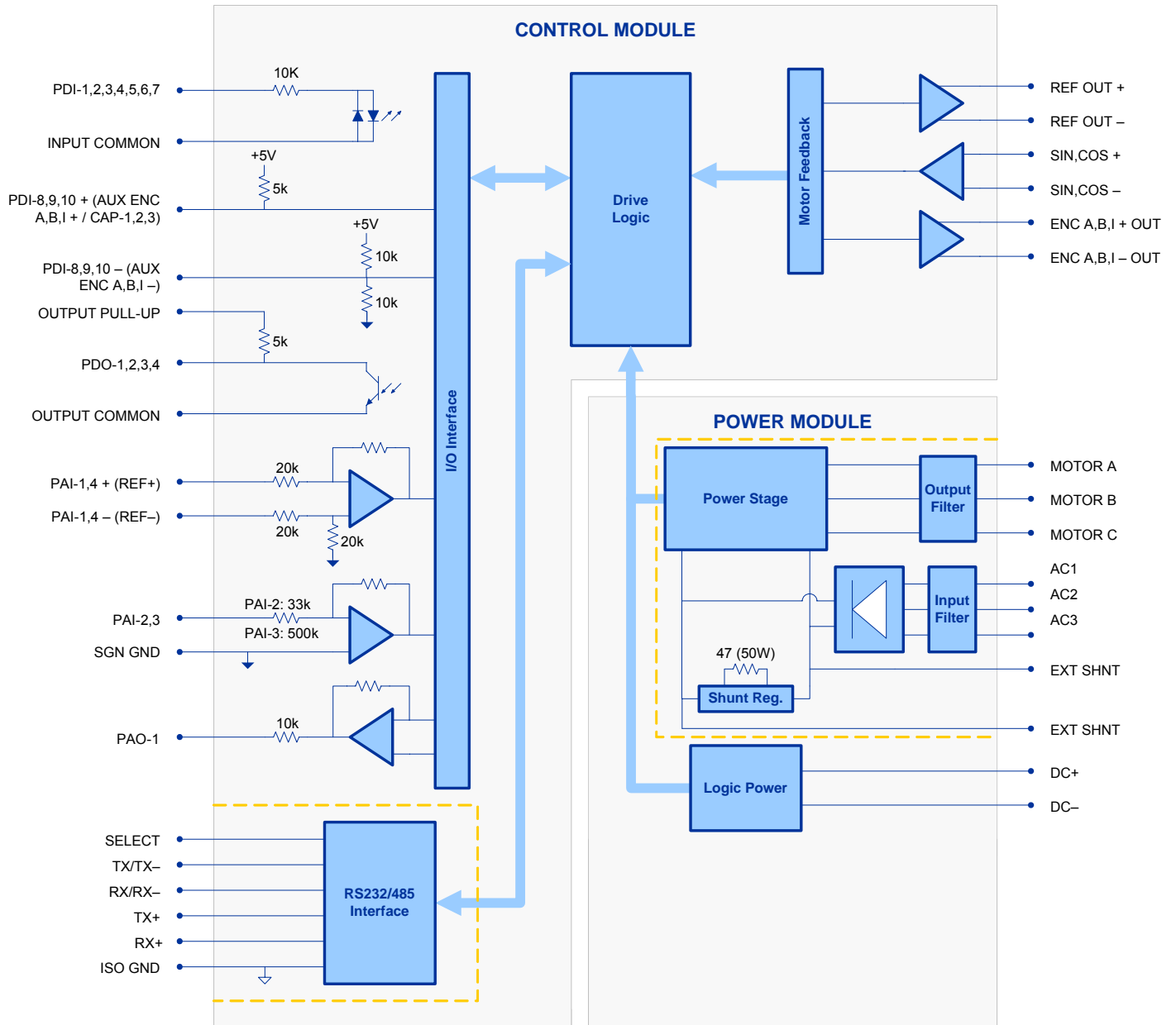
BLOCK DIAGRAM



Approvals and Compliances

	<p>US and Canadian safety compliance with UL 508c, the industrial standard for power conversion electronics. UL registered under file number E140173. Note that machine components compliant with UL are considered UL registered as opposed to UL listed as would be the case for commercial products.</p>
	<p>Compliant with European CE for both the Class A EMC Directive 89/336/EEC on Electromagnetic Compatibility (specifically EN 61000-6-4:2001, EN 61000-6-2:2001, EN 61000-3-2:2000, and EN 61000-3-3:1995/A1:2001) and LVD requirements of directive 73/23/EEC (specifically EN 60204-1), a low voltage directive to protect users from electrical shock.</p>
	<p>RoHS (Reduction of Hazardous Substances) is intended to prevent hazardous substances such as lead from being manufactured in electrical and electronic equipment.</p>

SPECIFICATIONS

Power Stage Specifications		
Description	Units	Value
AC Supply Voltage	VAC	155 - 480
DC Supply Voltage	VDC	220 - 800
Over Voltage Limit	VDC	850
Under Voltage Limit	VDC	215
Logic Supply Voltage	VDC	20 - 30
Peak Output Current	A	20
Maximum Continuous Output Current	A	10
Maximum Continuous Output Power	W	8000
Maximum Power Dissipation at Continuous Current	W	400
Internal Braking Resistor	-	Yes
Minimum Load Inductance (Line-To-Line) ¹	μH	3000
Switching Frequency	kHz	10
Control Specifications		
Description	Units	Value
Communication Interfaces	-	RS-232, RS-485
Command Sources	-	±10 V Analog, 5V Step & Direction, Encoder Following
Feedback Supported	-	±10 V Analog, Auxiliary Incremental Encoder, Resolver
Commutation Methods	-	Sinusoidal
Modes of Operation	-	Current, Position, Velocity
Motors Supported	-	Brushed, Brushless, Induction, Voice Coil
Hardware Protection	-	40+ Configurable Functions, Over Current, Over Temperature (Drive & Motor), Over Voltage, Short Circuit (Phase-Phase & Phase-Ground), Under Voltage
Programmable Digital Inputs/Outputs (PDIs/PDOs)	-	10/4
Programmable Analog Inputs/Outputs (PAIs/PAOs)	-	4/1
Current Loop Sample Time	μs	100
Velocity Loop Sample Time	μs	100
Position Loop Sample Time	μs	100
Resolver Reference/Excitation Signal	Vrms	4 Vrms @ 5 kHz
Expected Resolver Transformation Ratio	Vrms	0.5
Mechanical Specifications		
Description	Units	Value
Size (H x W x L)	mm (in)	330 x 256 x 63 (13 x 10.1 x 2.5)
Heatsink (Base) Temperature Range ²	°C (°F)	0 - 65 (32 - 149)
Storage Temperature Range	°C (°F)	-40 - 85 (-40 - 185)
Cooling System	-	Natural Convection
Form Factor	-	Stand Alone
IP Rating	-	IP10
AUX ENCODER Connector	-	15-pin, high-density, male D-sub
COMM Connector	-	9-pin, female D-sub
DC BUS Connector	-	4-port, 7.62 mm spaced, enclosed, friction lock header
FEEDBACK Connector	-	15-pin, high-density, female D-sub
I/O Connector	-	26-pin, high-density, female D-sub
MOTOR POWER Connector	-	4-port, 7.62 mm spaced, enclosed, friction lock header
POWER Connector	-	4-port, 7.62 mm spaced, enclosed, friction lock header

Notes

1. Low inductance motors, such as 'pancake' and 'basket-wound', require external inductors. The Minimum Load Inductance provided assumes the highest allowed bus voltage. Lower inductances are acceptable for lower bus voltages.
2. Additional cooling and/or heatsink may be required to achieve rated performance.

PIN FUNCTIONS

AUX ENCODER - Auxiliary Feedback Connector			
Pin	Name	Description / Notes	I/O
1	RESERVED	Reserved	-
2	RESERVED	Reserved	-
3	RESERVED	Reserved	-
4	PDI-8 + (AUX ENC A+ / CAP-2)	Programmable Digital Input or Auxiliary Encoder or High Speed Capture	I
5	PDI-8 - (AUX ENC A-)	Programmable Digital Input or Auxiliary Encoder (For Differential Signals Only)	I
6	PDI-9 + (AUX ENC B+ / CAP-2)	Programmable Digital Input or Auxiliary Encoder or High Speed Capture	I
7	PDI-9 - (AUX ENC B-)	Programmable Digital Input or Auxiliary Encoder (For Differential Signals Only)	I
8	PDI-10 + (AUX ENC I+ / CAP-1)	Programmable Digital Input or Auxiliary Encoder or High Speed Capture	I
9	PDI-10 - (AUX ENC I-)	Programmable Digital Input or Auxiliary Encoder (For Differential Signals Only)	I
10	SGN GND	Signal Ground	SGND
11	SGN GND	Signal Ground	SGND
12	SGN GND	Signal Ground	SGND
13	+5V OUT	+5V Encoder Supply Output (Short Circuit Protected)	O
14	PAI-4 +	Differential Programmable Analog Input	I
15	PAI-4 -		I

COMM - RS232/RS485 Communication Connector			
Pin	Name	Description / Notes	I/O
1	SELECT	RS232/485 selection. Pull to ground (CN1-5) for RS485.	I
2	RS232 TX / RS485 TX-	Transmit Line (RS-232 or RS-485)	O
3	RS232 RX / RS485 RX-	Receive Line (RS-232 or RS-485)	I
4	RESERVED	Reserved	-
5	ISO GND	Isolated Signal Ground	IGND
6	RS485 TX+	Transmit Line (RS-485)	O
7	RESERVED	Reserved	-
8	RS485 RX+	Receive Line (RS-485)	I
9	RESERVED	Reserved	-

DC BUS - Power Connector			
Pin	Name	Description / Notes	I/O
1	DC-	Internal DC Bus Voltage (Can Be Used To Connect External Shunt Regulator)	O
2	DC-		O
3	DC+		O
4	DC+		O

FEEDBACK - Feedback Connector			
Pin	Name	Description / Notes	I/O
1	RESERVED	Reserved	-
2	RESERVED	Reserved	-
3	RESERVED	Reserved	-
4	REF OUT +	Resolver Reference/Excitation Output	O
5	REF OUT -		O
6	SIN+	Resolver Sine Input	I
7	SIN-		I
8	COS+	Resolver Cosine Input	I
9	COS-		I
10	RESERVED	Reserved	-
11	RESERVED	Reserved	-
12	SGN GND	Signal Ground	SGND
13	+5V OUT	+5V Encoder Supply Output (Short Circuit Protected)	O
14	PAI-3	Programmable Analog Input	I
15	RESERVED	Reserved	-

I/O - Signal Connector			
Pin	Name	Description / Notes	I/O
1	PDO-1	Isolated Programmable Digital Output	O
2	OUTPUT COMMON	Digital Output Common	OGND
3	PDO-2	Isolated Programmable Digital Output	O
4	PAI-1 + (REF+)	Differential Programmable Analog Input or Reference Signal Input	I
5	PAI-1 - (REF-)		I
6	PAI-2	Programmable Analog Input	I
7	PAO-1	Programmable Analog Output	O
8	OUTPUT PULL-UP	Digital Output Pull-Up	I
9	PDI-5	Isolated Programmable Digital Input	I
10	PDO-3	Isolated Programmable Digital Output	O
11	PDI-1	Isolated Programmable Digital Input	I
12	PDI-2	Isolated Programmable Digital Input	I
13	PDI-3	Isolated Programmable Digital Input	I
14	PDO-4	Isolated Programmable Digital Output	O
15	INPUT COMMON	Digital Input Common (Can Be Used To Pull-Up Digital Inputs)	IGND
16	SGN GND	Signal Ground	SGND
17	PDI-4	Isolated Programmable Digital Input	I
18	PDI-6	Isolated Programmable Digital Input	I
19	PDI-7	Isolated Programmable Digital Input	I
20	ENC A+ OUT	Emulated Encoder Channel A Output	O
21	ENC A- OUT		O
22	ENC B+ OUT	Emulated Encoder Channel B Output	O
23	ENC B- OUT		O
24	ENC I+ OUT	Emulated Encoder Index Output	O
25	ENC I- OUT		O
26	SGN GND	Signal Ground	SGND

MOTOR POWER - Power Connector			
Pin	Name	Description / Notes	I/O
1	PE	Protective Earth Ground	PE
2	MOTOR C	Motor Phase C	O
3	MOTOR B	Motor Phase B	O
4	MOTOR A	Motor Phase A	O

POWER - Power Connector			
Pin	Name	Description / Notes	I/O
1	PE	Protective Earth Ground	PE
2	AC3	AC Supply Input (Single Or Three Phase)	I
3	AC2		I
4	AC1		I

HARDWARE SETTINGS

Switch Functions

Switch	Description	Setting	
		On	Off
1	Bit 0 of binary value of drive address/ID.	1	0
2	Bit 1 of binary value of drive address/ID.	1	0
3	Bit 2 of binary value of drive address/ID.	1	0
4	Bit 3 of binary value of drive address/ID.	1	0
5	Bit 4 of binary value of drive address/ID.	1	0
6	Bit 5 of binary value of drive address/ID.	1	0
7	Bit 0 of binary value of drive bit rate setting.	1	0
8	Bit 1 of binary value of drive bit rate setting.	1	0

Additional Details

The drive can be configured to use the address and/or bit rate stored in non-volatile memory by setting the address and/or bit rate value to 0. Use the table below to map actual bit rates to a bit rate setting.

Bit Rate (kbits/sec)		Value For Bit Rate Setting
CANopen	RS-485	
Load from non-volatile memory	Load from non-volatile memory	0
500	9.6	1
250	38.4	2
125	115.2	3

MECHANICAL INFORMATION
AUX ENCODER - Auxiliary Feedback Connector

Connector Information	15-pin, high-density, male D-sub
Mating Connector	AMP: Plug P/N 748365-1; Housing P/N 748677-1; Terminals P/N 748610-4 (loose) or 748610-2 (strip)

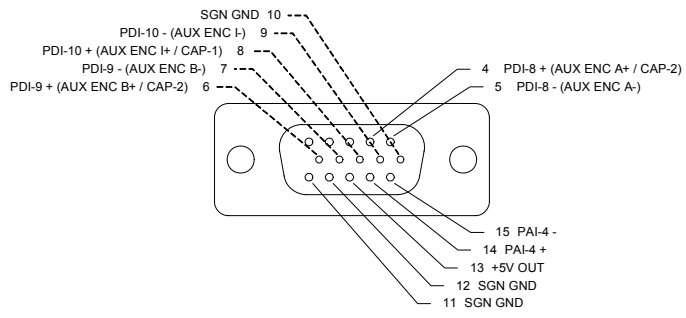
COMM - RS232/RS485 Communication Connector

Connector Information	9-pin, female D-sub
Mating Connector	AMP: Plug P/N 205204-4; Housing P/N 748677-1; Terminals P/N 5-66507-7 (loose) or 3-66507-0 (strip)

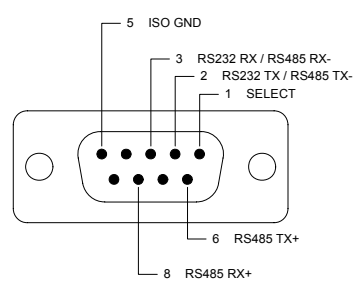
DC BUS - Power Connector

Connector Information	4-port, 7.62 mm spaced, enclosed, friction lock header
Mating Connector	Phoenix Contact: P/N 1804920

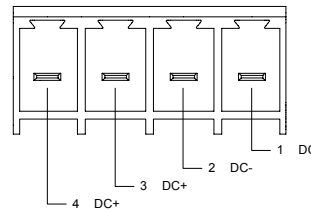

FEEDBACK - Feedback Connector

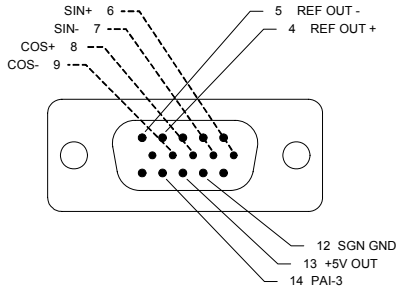
Connector Information	15-pin, high-density, female D-sub
Mating Connector	AMP: Plug P/N 748365-1; Housing P/N 748677-1; Terminals P/N 748333-4 (loose) or 748333-2 (strip)

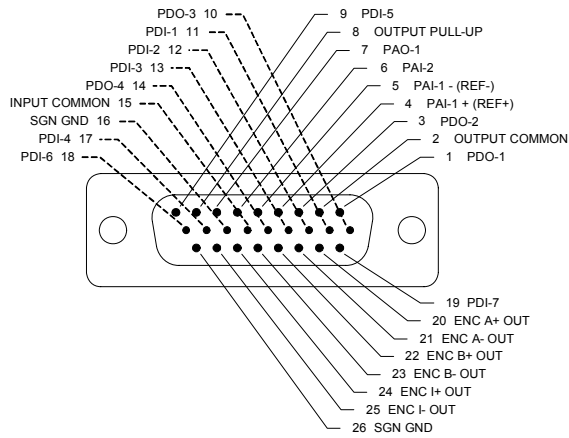

I/O - Signal Connector

Connector Information	26-pin, high-density, female D-sub
Mating Connector	AMP: Plug P/N 748365-1; Housing P/N 748677-2; Terminals P/N 748333-4 (loose) or 748333-2 (strip)



MOTOR POWER - Power Connector

Connector Information	4-port, 7.62 mm spaced, enclosed, friction lock header
Mating Connector	Phoenix Contact: P/N 1804920

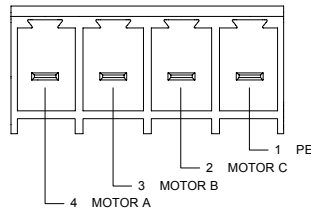

POWER - Power Connector

Connector Information	4-port, 7.62 mm spaced, enclosed, friction lock header
Mating Connector	Phoenix Contact: P/N 1804920

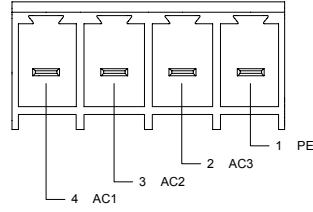

PART NUMBERING INFORMATION

Example: **D P R A N I E - 0 1 5 A 4 0 0**

Drive Series	
DP	DigiFlex Performance

Communication	
R	RS232/RS485
C	CANopen or RS232
Q	SynqNet

Command Inputs	
AN	Analog (±10V) No Step & Direction
AL	Analog (±10V) Low Voltage Step & Direction (5V)
AH	Analog (±10V) High Voltage Step & Direction (24V)
NL	No Analog Low Voltage Step & Direction (5V)
NN	No Analog, No Step & Direction (Communication Interface Only)

Digital I/O	
I	Isolated (24V)
T	TTL (5V) Non-Isolated

Motor Feedback	
E	Incremental Encoder and/or Halls
R	Resolver
A	Absolute Sin/Cos (Hiperface & Endat)
S	Sin/Cos with Halls

Max DC Bus Voltage (V _{DC})	
080	80
200	200
400	400
800	800

Power and Logic Supply	
A	AC Input +24V _{DC} User Logic Supply Required
N	AC Input Only No Logic Supply Required (Internal Supply)
B	DC Input Both Logic Supply Options (Internal or User)
L	DC Input Logic Supply Required
D	DC Input Only Internal Logic Supply

Peak Current (A _{0 to Peak})	
015	15
016	16
020	20
025	25
030	30
040	40
060	60
100	100

DigiFlex® Performance™ series of products are available in many configurations. All models listed on the website are readily available, standard product offerings. Other combinations or possibilities can be made available for OEMs with volume requests of 100 or more. Contact Applications Engineering for further information and details.

All specifications in this document are subject to change without written notice. Actual product may differ from pictures provided in this document.